



HK3020-2RS

Drawn cup needle roller bearing open end

Schaeffler ID:
0007909740968

Drawn cup needle roller bearings with open ends HK..-2RS, lip seals on both sides, to DIN 618

Technical information

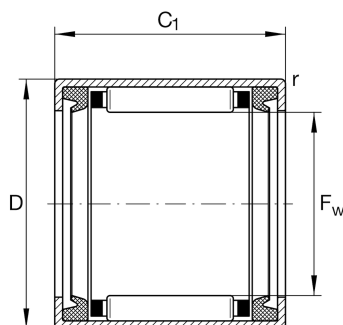

Main Dimensions & Performance Data

F_w	30 mm	Under roller diameter
D	37 mm	Outside diameter
C	20 mm	Width
C_r	17,200 N	Basic dynamic load rating, radial
C_{0r}	29,000 N	Basic static load rating, radial
C_{ur}	3,850 N	Fatigue load limit, radial
n_G	5,200 1/min	Limiting speed
$n_{G \text{ Grease}}$	5,200 1/min	Limiting speed for grease lubrication
	35.91 g	Weight

Dimensions

C_1	20 mm	Width, outer ring
r_{\min}	0.8 mm	Minimum chamfer dimension
	LR25X30X20,5	Suitable inner rings LR
	IR25X30X20-XL	Suitable inner rings IR

Temperature range

T_{\min}	-20 °C	Operating temperature min.
T_{\max}	100 °C	Operating temperature max.